

IC-5150W

Instrukcja Szybkiej Instalacji

12-2015 / v1.0

Edimax Technology Co., Ltd.

No.3, Wu-Chuan 3rd Road, Wu-Gu, New Taipei City 24891, Taiwan

Email: support@edimax.com.tw

Edimax Technology Europe B.V.

Fijenhof 2, 5652 AE Eindhoven, The Netherlands

Email: support@edimax.nl

Edimax Computer Company

3350 Scott Blvd., Bldg.15 Santa Clara, CA 95054, USA

Live Tech Support: 1(800) 652-6776

Email: support@edimax.com

Zawartość opakowania



IC-5150W



QIG



CD-ROM



**Zasilacz
sieciowy**



**Kabel
Ethernet**

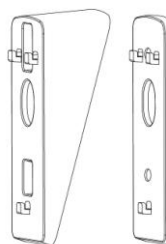

**Zestaw
montażowy**



Wkręty

Stany wskaźników LED

Dioda	Kolor	Stan wskaźnika	Opis
Zasilanie	Zielony	Włączony	Kamera sieciowa jest włączona i jest połączona z Internetem.
		Miga szybko	Kamera sieciowa uruchamia się ponownie.
		Miga powoli (1 na sekundę)	Kamera jest w trybie instalacyjnym lub nie jest połączona z serwerem chmury.
LAN	Zielony	Włączony	Kamera sieciowa jest połączona z siecią lokalną.
		Miga szybko	Aktywność LAN (przesyłanie danych).
		Miga powoli (1 na sekundę)	WPS jest aktywny.
Internet	Pomarańczowy	Włączony	Kamera sieciowa jest połączona z Internetem.
		Miga powoli (1 na sekundę)	Kamera sieciowa nie jest połączona z Internetem .

Konfiguracja kamery

Postępuj zgodnie z poniższymi poleceniami aby skonfigurować kamerę sieciową za pomocą aplikacji EdiLife na urządzenia mobilne. Możesz też skonfigurować kamerę korzystając z kabla Ethernet lub z oprogramowania EdiView Finder na komputerze – szczegóły na ten temat znajdziesz w instrukcji użytkownika.



Na etykiecie produktu znajdującej się na odwrocie kamery znajduje się unikatowa nazwa sieci bezprzewodowej Twojej kamery. Ma ona formę "EdiView.Setup **" gdzie ** to dwa ostatnie znaki unikatowego adresu MAC kamery.

- 1.** Podłącz kamerę do źródła zasilania używając załączonego zasilacza sieciowego.

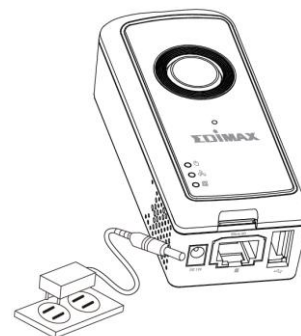

- 2.** Poczekaj aż kamera się uruchomi. Gdy kamera będzie gotowa, dioda zasilania zacznie wolno migać **na zielono**.

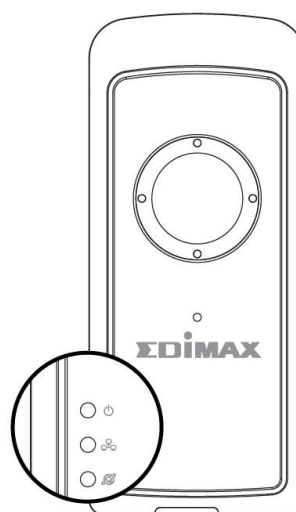

3. Użyj urządzenia mobilnego aby odnaleźć i zainstalować aplikację EdiLife z Google Play lub Apple App Store.



4. Jeżeli jesteś użytkownikiem **systemu iOS**, przed uruchomieniem aplikacji EdiLife przejdź do konfiguracji Wi-Fi swojego iPhone'a i połącz się z siecią swojej kamery (EdiView.Setup **). Następnie przejdź do **Kroku 7**.

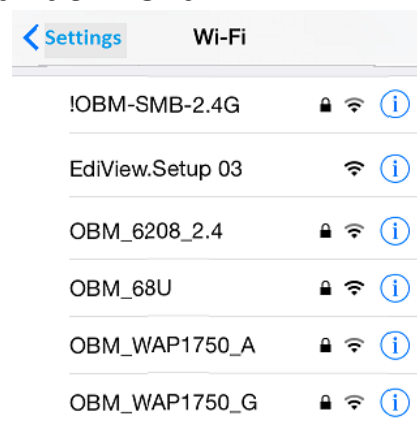

5. Jeżeli jesteś użytkownikiem **systemu Android**, uruchom aplikację EdiLife i kliknij ikonę + w prawym górnym rogu ekranu.

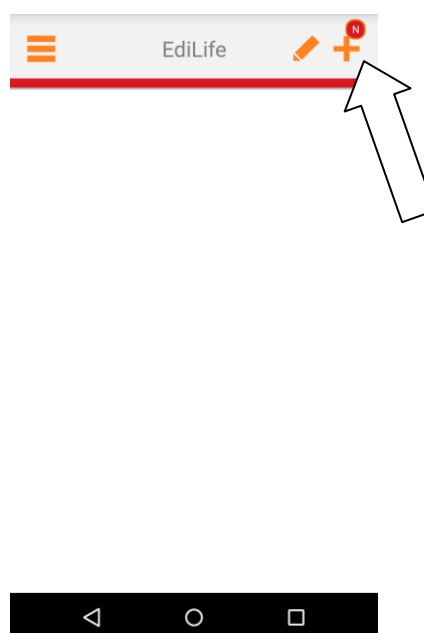
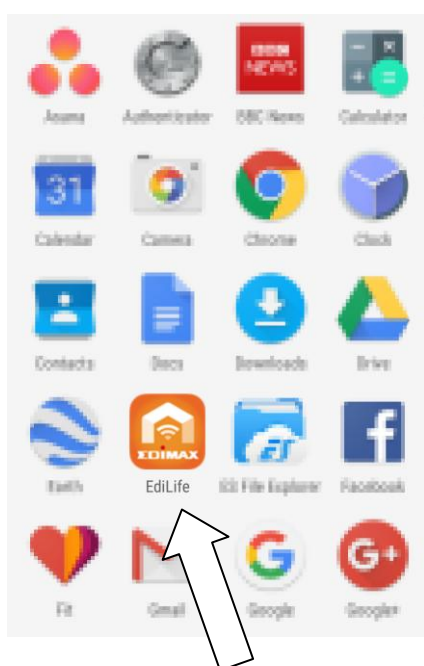

- 6.** Jeżeli jesteś użytkownikiem systemu **Android**, wybierz swoją kamerę z **listy dostępnych urządzeń bezprzewodowych** i poczekaj chwilę aż aplikacja połączy się z nią.

Jeśli Twojej kamery nie ma na liście, kliknij odśwież w prawy górnym rogu ekranu.

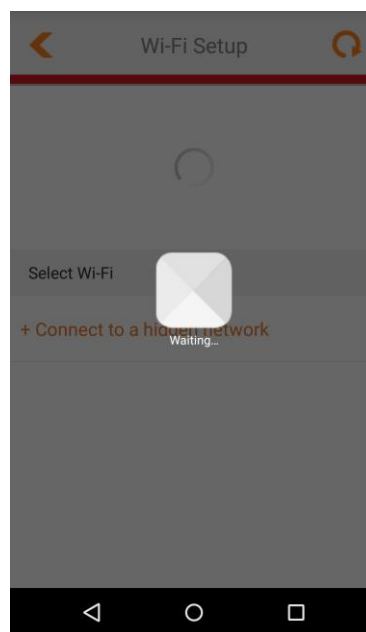
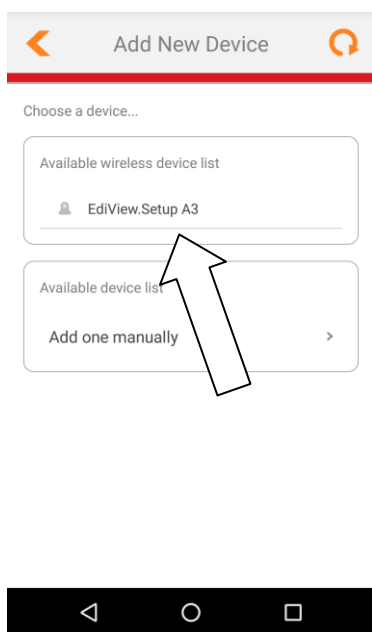

- 7.** Żeby zwiększyć bezpieczeństwo zmień nazwę i hasło kamery, gdy zostaniesz o to poproszony, a następnie kliknij **Gotowe**.

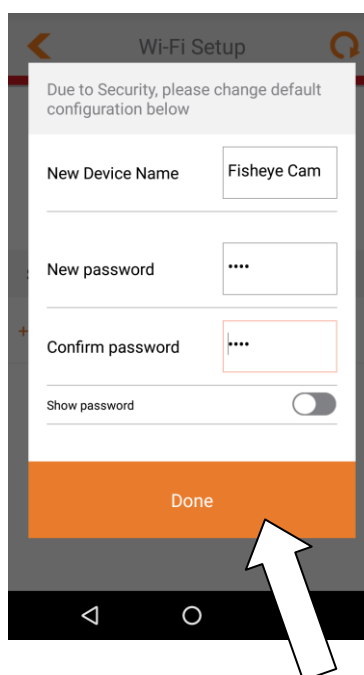
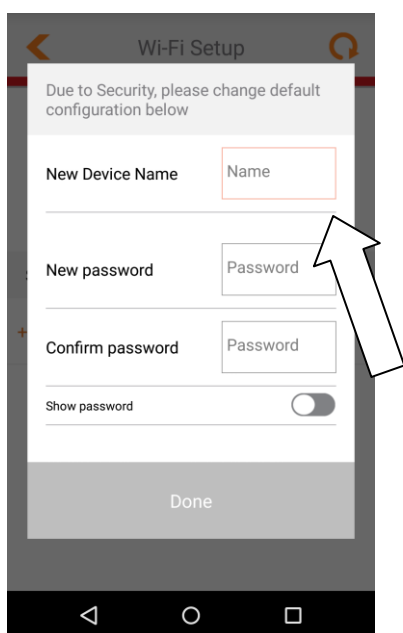

8. Wybierz z listy swoją sieć bezprzewodową, wprowadź hasło, którym jest zabezpieczona, a następnie kliknij **OK**.

Jeśli Twojej sieci nie ma na liście, kliknij odśwież w prawy górnym rogu ekranu.

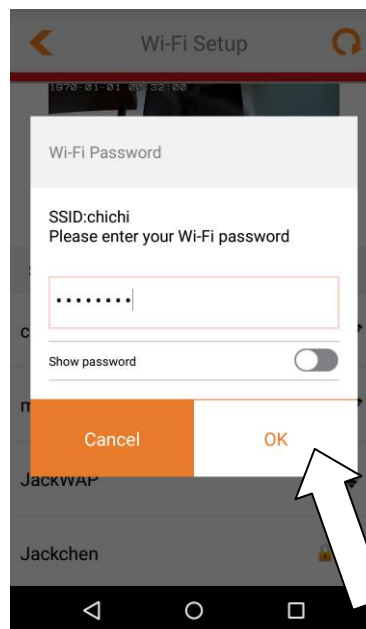
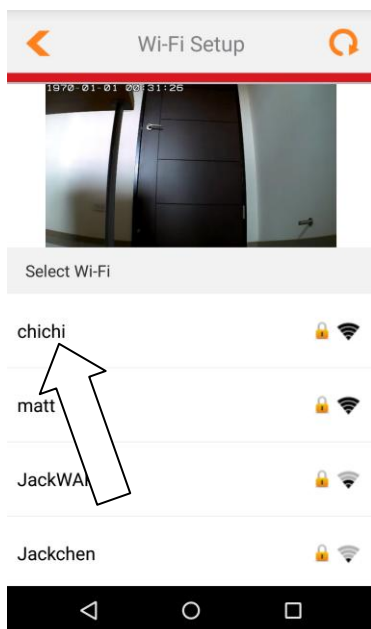

9. Poczekaj aż kamera połączy się z Twoją siecią bezprzewodową. Gdy zobaczysz ekran **Konfiguracja zakończona**, kliknij **Obraz** lub strzałkę żeby kontynuować.

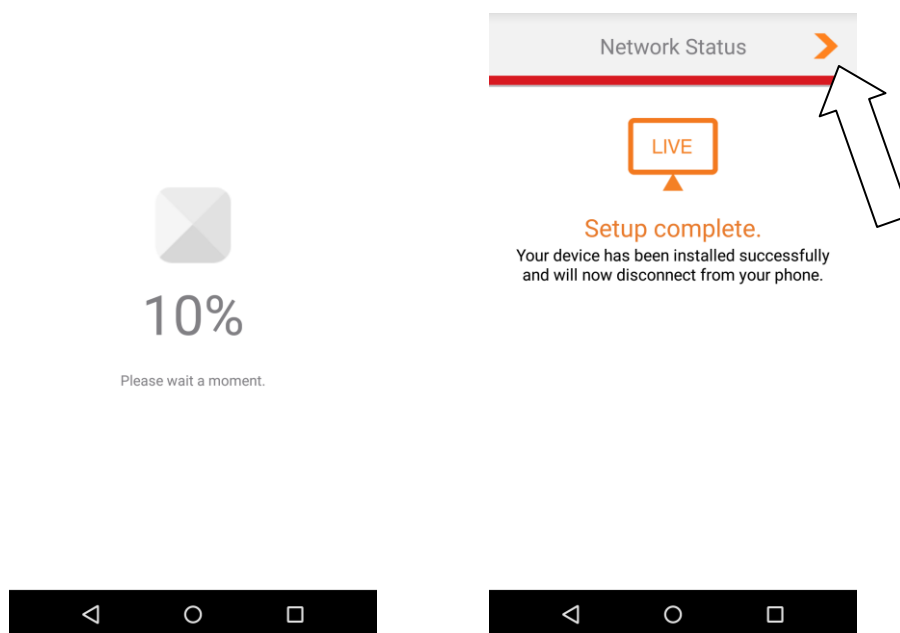

10. Konfiguracja zakończona. **Zielona** dioda zasilania i **pomarańczowa** dioda Internet powinny świecić **stałym** światłem. Twoja kamera powinna znajdować się stronie głównej EdiLife. Kliknij kamerę, żeby zobaczyć podgląd na żywo wszędzie tam, gdzie będziesz miał dostęp do Internetu.

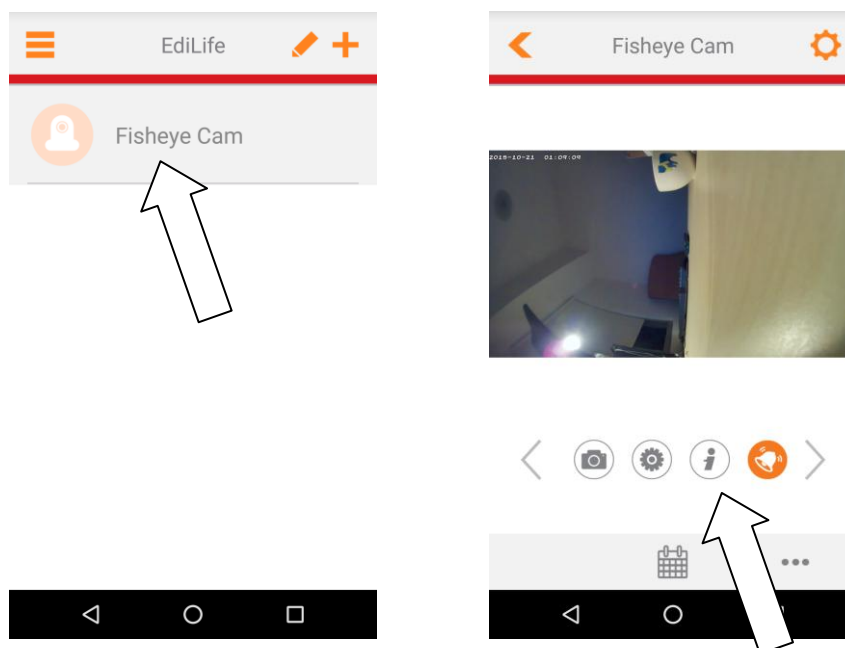

Funkcje i ustawienia kamery możesz zmieniać za pomocą ikon poniżej podglądu obrazu.

11. Jeżeli masz kartę microSD, umieść ją w gnieździe microSD na tylnym panelu kamery sieciowej:

WPS

Przycisk WPS (Wi-Fi Protected Setup) stanowi szybką i prostą do użycia alternatywę nawiązania bezpiecznego połączenia bezprzewodowego pomiędzy kamerą sieciową a routerem bezprzewodowym lub punktem dostępu.

1. Wciśnij i przytrzymaj przycisk WPS na **routerze bezprzewodowym** lub **punkcie dostępu** tak długo, jak trzeba, aby aktywować jego funkcję WPS.



W instrukcji do swojego routera bezprzewodowego lub punktu dostępu sprawdź jak długo należy trzymać przycisk WPS aby aktywować tę funkcję.

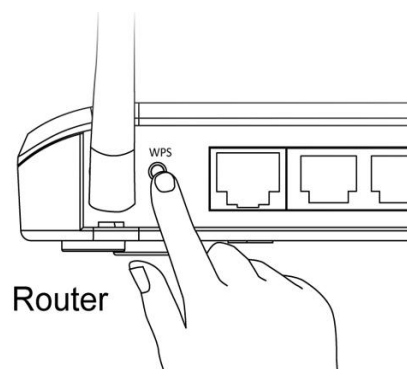

2. W ciągu dwóch minut wciśnij i przytrzymaj przez 2 – 5 sekund przycisk WPS/Reset znajdujący się na kamerze, aby aktywować WPS. **Zielona** dioda LAN zacznie **powoli migać** wskazując, że WPS jest aktywny.



Uważaj, żeby nie przytrzymać przycisku WPS/Reset zbyt długo, może to doprowadzić do resetu kamery sieciowej.

3. Urządzenia nawiążą bezpieczne połączenie bezprzewodowe. Dioda LED będzie przez 2 minuty **szybko migać zielonym** światłem wskazując, że połączenie WPS się powiodło.



Użytkowanie kamery sieciowej

W przeglądarce możesz używać strony konfiguracyjnej kamery aby na żywo oglądać obraz z kamery oraz korzystać z jej funkcji, takich jak wykrywanie ruchu i dźwięku.

Wprowadź adres IP kamery w pasku adresu przeglądarki uruchomionej na komputerze połączonym z tą samą siecią lokalną, co kamera:

 **Adres IP kamery znajdziesz korzystając z programu komputerowego EdiView Finder lub aplikacji EdiLife na smartfona (w sekcji Ustawienia). Szczegóły znajdziesz w instrukcji użytkownika.**

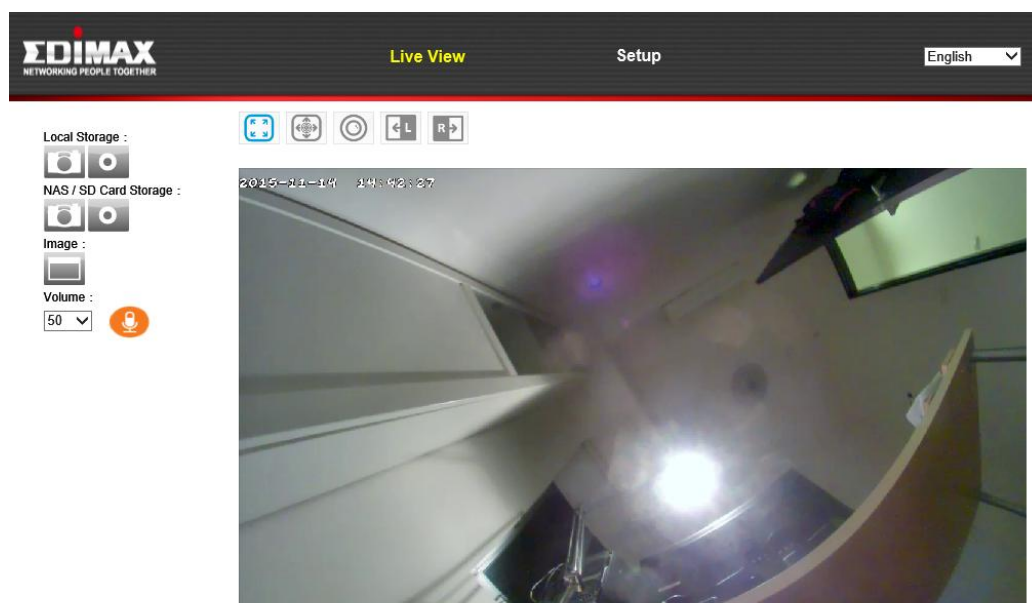
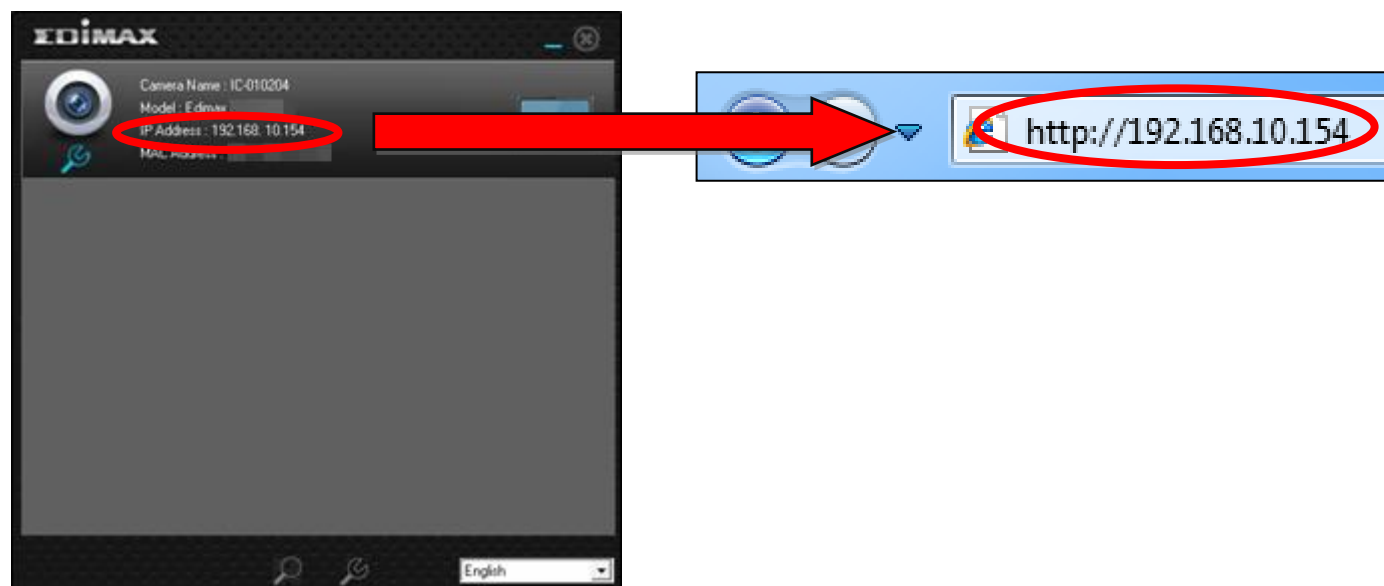

Montaż

Dołączony zestaw montażowy umożliwia instalację kamery na ścianie. Zestaw wymaga złożenia.

- 1.** Za pomocą wkrętów zamocuj uchwyt na ścianie, tak jak to pokazano na rysunku poniżej:

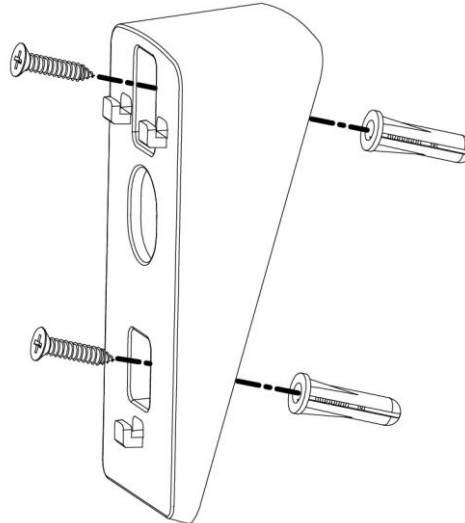

- 2.** Zamocuj kamerę sieciową na uchwycie i ustaw kamerę w dogodnej pozycji, tak jak to pokazano na rysunku poniżej:

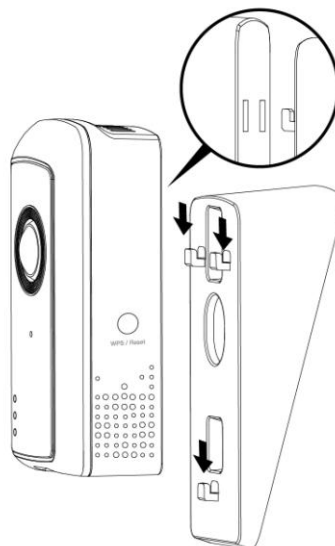

Reset

Jeżeli kamera nie działa prawidłowo, możesz zresetować ją do ustawień fabrycznych. Wtedy **cała** konfiguracja kamery powróci do stanu fabrycznego.

- 1.** Przytrzymaj znajdujący się z boku urządzenia przycisk WPS/Reset przez co najmniej 10 sekund.
- 2.** Puść przycisk gdy dioda zasilania zacznie **szybko migać na zielono**.
- 3.** Poczekaj aż kamera sieciowa uruchomi się ponownie. Będzie ona gotowa do pracy, gdy wskaźnik LED zacznie **powoli migać na zielono**.



Po zakończeniu konfiguracji dioda zasilania będzie świecić się na stałe na zielono. Świadczy to o pomyślnym połączeniu z serwerem chmury.



Federal Communication Commission Interference Statement

This equipment has been tested and found to comply with the limits for a Class B digital device, pursuant to Part 15 of FCC Rules. These limits are designed to provide reasonable protection against harmful interference in a residential installation. This equipment generates, uses, and can radiate radio frequency energy and, if not installed and used in accordance with the instructions, may cause harmful interference to radio communications. However, there is no guarantee that interference will not occur in a particular installation. If this equipment does cause harmful interference to radio or television reception, which can be determined by turning the equipment off and on, the user is encouraged to try to correct the interference by one or more of the following measures:

1. Reorient or relocate the receiving antenna.
2. Increase the separation between the equipment and receiver.
3. Connect the equipment into an outlet on a circuit different from that to which the receiver is connected.
4. Consult the dealer or an experienced radio technician for help.

FCC Caution

Any changes or modifications not expressly approved by the party responsible for compliance could void the authority to operate equipment.

This device complies with Part 15 of the FCC Rules. Operation is subject to the following two conditions: (1) this device may not cause harmful interference, and (2) this device must accept any interference received, including interference that may cause undesired operation.

FCC Radiation Exposure Statement:

This equipment complies with FCC radiation exposure limits set forth for an uncontrolled environment. This equipment should be installed and operated with minimum distance 20cm between the radiator & your body. For product available in the USA/Canada market, only channel 1~11 can be operated. Selection of other channels is not possible. This device and its antenna(s) must not be co-located or operating in conjunction with any other antenna or transmitter.

R&TTE Compliance Statement

This equipment complies with all the requirements of DIRECTIVE 1999/5/EC OF THE EUROPEAN PARLIAMENT AND THE COUNCIL of March 9, 1999 on radio equipment and telecommunication terminal equipment and the mutual recognition of their conformity (R&TTE). The R&TTE Directive repeals and replaces in the directive 98/13/EEC (Telecommunications Terminal Equipment and Satellite Earth Station Equipment) As of April 8, 2000.

Safety

This equipment is designed with the utmost care for the safety of those who install and use it. However, special attention must be paid to the dangers of electric shock and static electricity when working with electrical equipment. All guidelines of this and of the computer manufacture must therefore be allowed at all times to ensure the safe use of the equipment.

EU Countries Intended for Use

The ETSI version of this device is intended for home and office use in Austria, Belgium, Bulgaria, Cyprus, Czech, Denmark, Estonia, Finland, France, Germany, Greece, Hungary, Ireland, Italy, Latvia, Lithuania, Luxembourg, Malta, Netherlands, Poland, Portugal, Romania, Slovakia, Slovenia, Spain, Sweden, Turkey, and United Kingdom. The ETSI

version of this device is also authorized for use in EFTA member states: Iceland, Liechtenstein, Norway, and Switzerland.

EU Countries Not Intended for Use

None

EU Declaration of Conformity

- English:** This equipment is in compliance with the essential requirements and other relevant provisions of Directive 1995/95/EC, 2011/65/EC.
- Français:** Cet équipement est conforme aux exigences essentielles et autres dispositions de la directive 1995/95/CE, 2011/65/CE.
- Čeština:** Toto zařízení je v souladu se základními požadavky a ostatními příslušnými ustanoveními směrnic 1995/95/ES, 2011/65/ES.
- Polski:** Urządzenie jest zgodne z ogólnymi wymaganiami oraz szczególnymi warunkami określonymi Dyrektywą UE 1995/95/EC, 2011/65/EC..
- Română:** Acest echipament este în conformitate cu cerințele esențiale și alte prevederi relevante ale Directivei 1995/95/CE, 2011/65/CE.
- Русский:** Это оборудование соответствует основным требованиям и положениям Директивы 1995/95/EC, 2011/65/EC.
- Magyar:** Ez a berendezés megfelel az alapvető követelményeknek és más vonatkozó irányelveknek (1995/95/EK, 2011/65/EK).
- Türkçe:** Bu cihaz 1995/95/EC, 2011/65/EC direktifleri zorunlu istekler ve diğer hükümlerle ile uyumludur.
- Українська:** Обладнання відповідає вимогам і умовам директиви 1995/95/EC, 2011/65/EC.
- Slovenčina:** Toto zariadenie spĺňa základné požiadavky a ďalšie príslušné ustanovenia smerníc 1995/95/ES, 2011/65/ES.
- Deutsch:** Dieses Gerät erfüllt die Voraussetzungen gemäß den Richtlinien 1995/95/EC, 2011/65/EC.
- Español:** El presente equipo cumple los requisitos esenciales de la Directiva 1995/95/EC, 2011/65/EC.
- Italiano:** Questo apparecchio è conforme ai requisiti essenziali e alle altre disposizioni applicabili della Direttiva 1995/95/CE, 2011/65/CE.
- Nederlands:** Dit apparaat voldoet aan de essentiële eisen en andere van toepassing zijnde bepalingen van richtlijn 1995/95/EC, 2011/65/EC..
- Português:** Este equipamento cumpre os requisitos essenciais da Directiva 1995/95/EC, 2011/65/EC.
- Norsk:** Dette utstyret er i samsvar med de viktigste kravene og andre relevante regler i Direktiv 1995/95/EC, 2011/65/EC.
- Svenska:** Denna utrustning är i överensstämmelse med de väsentliga kraven och övriga relevanta bestämmelser i direktiv 1995/95/EG, 2011/65/EG.
- Dansk:** Dette udstyr er i overensstemmelse med de væsentligste krav og andre relevante forordninger i direktiv 1995/95/EC, 2011/65/EC.
- suomen kieli:** Tämä laite täyttää direktiivien 1995/95/EY, 2011/65/EY oleelliset vaatimukset ja muut asiaankuuluvat määräykset.

FOR USE IN

AT	BE	CY	CZ	DK	EE	FI	FR
DE	GR	HU	IE	IT	LV	LT	LU
MT	NL	PL	PT	SK	SI	ES	SE
GB	IS	LI	NO	CH	BG	RO	TR



WEEE Directive & Product Disposal



At the end of its serviceable life, this product should not be treated as household or general waste. It should be handed over to the applicable collection point for the recycling of electrical and electronic equipment, or returned to the supplier for disposal.

Declaration of Conformity

We, Edimax Technology Co., Ltd., declare under our sole responsibility, that the equipment described below complies with the requirements of the European R&TTE directive (1999/5/EC, 2006/95/EC) .

Equipment: 2MP Fisheye Wi-Fi Network Camera
Model No.: IC-5150W

The following European standards for essential requirements have been followed:

Spectrum: ETSI EN 300 328 V1.9.1 (2015-02)
EMC: EN 301 489-1 V1.9.2 (2011-09);
EN 301 489-17 V2.2.1 (2012-09)
EMF: EN 62311:2008
Safety (LVD): IEC 60950-1:2005 (2nd Edition);Am1:2009;Am2:2013
EN-60950-1:2006+A11:2009+A1:2010+A12:2011+A2:2013

Edimax Technology Europe B.V.
Fijenhof 2,
5652 AE Eindhoven
THE NETHERLANDS

a company of :
Edimax Technology Co., Ltd.,
No. 3, Wu Chuan 3rd Road,
Wu-Ku Industrial Park,
New Taipei City, Taiwan

Signature:

Printed Name: Vivian Ma
Title: Director
Edimax Technology Europe B.V.



Date of Signature: Dec. 30, 2015
Signature: *John Hsieh*
Printed Name: John Hsieh
Title: Director
Edimax Technology Co., Ltd.

Notice According to GNU General Public License Version 2

This product includes software that is subject to the GNU General Public License version 2. The program is free software and distributed without any warranty of the author. We offer, valid for at least three years, to give you, for a charge no more than the costs of physically performing source distribution, a complete machine-readable copy of the corresponding source code.

Das Produkt beinhaltet Software, die den Bedingungen der GNU/GPL-Version 2 unterliegt. Das Programm ist eine sog. „Free Software“, der Autor stellt das Programm ohne irgendeine Gewährleistungen zur Verfügung. Wir bieten Ihnen für einen Zeitraum von drei Jahren an, eine vollständige maschinenlesbare Kopie des Quelltextes der Programme zur Verfügung zu stellen – zu nicht höheren Kosten als denen, die durch den physikalischen Kopiervorgang anfallen.

GNU GENERAL PUBLIC LICENSE

Version 2, June 1991

Copyright (C) 1989, 1991 Free Software Foundation, Inc. 51 Franklin Street, Fifth Floor, Boston, MA 02110-1301, USA
Everyone is permitted to copy and distribute verbatim copies of this license document, but changing it is not allowed.

Preamble

The licenses for most software are designed to take away your freedom to share and change it. By contrast, the GNU General Public License is intended to guarantee your freedom to share and change free software—to make sure the software is free for all its users. This General Public License applies to most of the Free Software Foundation's software and to any other program whose authors commit to using it. (Some other Free Software Foundation software is covered by the GNU Lesser General Public License instead.) You can apply it to your programs, too.

When we speak of free software, we are referring to freedom, not price. Our General Public Licenses are designed to make sure that you have the freedom to distribute copies of free software (and charge for this service if you wish), that you receive source code or can get it if you want it, that you can change the software or use pieces of it in new free programs; and that you know you can do these things.

To protect your rights, we need to make restrictions that forbid anyone to deny you these rights or to ask you to surrender the rights. These restrictions translate to certain responsibilities for you if you distribute copies of the software, or if you modify it.

For example, if you distribute copies of such a program, whether gratis or for a fee, you must give the recipients all the rights that you have. You must make sure that they, too, receive or can get the source code. And you must show them these terms so they know their rights.

We protect your rights with two steps: (1) copyright the software, and (2) offer you this license which gives you legal permission to copy, distribute and/or modify the software.

Also, for each author's protection and ours, we want to make certain that everyone understands that there is no warranty for this free software. If the software is modified by someone else and passed on, we want its recipients to know that what they have is not the original, so that any problems introduced by others will not reflect on the original authors' reputations.

Finally, any free program is threatened constantly by software patents. We wish to avoid the danger that redistributors of a free program will individually obtain patent licenses, in effect making the program proprietary. To prevent this, we have made it clear that any patent must be licensed for everyone's free use or not licensed at all.

The precise terms and conditions for copying, distribution and modification follow.

TERMS AND CONDITIONS FOR COPYING, DISTRIBUTION AND MODIFICATION

0. This License applies to any program or other work which contains a notice placed by the copyright holder saying it may be distributed under the terms of this General Public License. The "Program", below, refers to any such program or work, and a "work based on the Program" means either the Program or any derivative work under copyright law: that is to say, a work containing the Program or a portion of it, either verbatim or with modifications and/or translated into another language. (Hereinafter, translation is included without limitation in the term "modification".) Each licensee is addressed as "you".

Activities other than copying, distribution and modification are not covered by this License; they are outside its scope. The act of running the Program is not restricted, and the output from the Program is covered only if its contents constitute a work based on the Program (independent of having been made by running the Program). Whether that is true depends on what the Program does.

1. You may copy and distribute verbatim copies of the Program's source code as you receive it, in any medium, provided that you conspicuously and appropriately publish on each copy an appropriate copyright notice and disclaimer of warranty; keep intact all the notices that refer to this License and to the absence of any warranty; and give any other recipients of the Program a copy of this License along with the Program.

You may charge a fee for the physical act of transferring a copy, and you may at your option offer warranty protection in exchange for a fee.

2. You may modify your copy or copies of the Program or any portion of it, thus forming a work based on the Program, and copy and distribute such modifications or work under the terms of Section 1 above, provided that you also meet all of these conditions:

- a) You must cause the modified files to carry prominent notices stating that you changed the files and the date of any change.
- b) You must cause any work that you distribute or publish, that in whole or in part contains or is derived from the Program or any part thereof, to be licensed as a whole at no charge to all third parties under the terms of this License.
- c) If the modified program normally reads commands interactively when run, you must cause it, when started running for such interactive use in the most ordinary way, to print or display an announcement including an appropriate copyright notice and a notice that there is no warranty (or else, saying that you provide a warranty) and that users may redistribute the program under these conditions, and telling the user how to view a copy of this License. (Exception: if the Program itself is interactive but does not normally print such an announcement, your work based on the Program is not required to print an announcement.)

These requirements apply to the modified work as a whole. If identifiable sections of that work are not derived from the Program, and can be reasonably considered independent and separate works in themselves, then this License, and its terms, do not apply to those sections when you distribute them as separate works. But when you distribute the same sections as part of a whole which is a work based on the Program, the distribution of the whole must be on the terms of this License, whose permissions for other licensees extend to the entire whole, and thus to each and every part regardless of who wrote it.

Thus, it is not the intent of this section to claim rights or contest your rights to work written entirely by you; rather, the intent is to exercise the right to control the distribution of derivative or collective works based on the Program.

In addition, mere aggregation of another work not based on the Program with the Program (or with a work based on the Program) on a volume of a storage or distribution medium does not bring the other work under the scope of this License.

3. You may copy and distribute the Program (or a work based on it, under Section 2) in object code or executable form under the terms of Sections 1 and 2 above provided that you also do one of the following:

- a) Accompany it with the complete corresponding machine-readable source code, which must be distributed under the terms of Sections 1 and 2 above on a medium customarily used for software interchange; or,
- b) Accompany it with a written offer, valid for at least three years, to give any third party, for a charge no more than your cost of physically performing source distribution, a complete machine-readable copy of the corresponding source code, to be distributed under the terms of Sections 1 and 2 above on a medium customarily used for software interchange; or,
- c) Accompany it with the information you received as to the offer to distribute corresponding source code. (This alternative is allowed only for noncommercial distribution and only if you received the program in object code or executable form with such an offer, in accord with Subsection b above.)

The source code for a work means the preferred form of the work for making modifications to it. For an executable work, complete source code means all the source code for all modules it contains, plus any associated interface definition files, plus the scripts used to control compilation and installation of the executable. However, as a special exception, the source code distributed need not include anything that is normally distributed (in either source or binary form) with the major components (compiler, kernel, and so on) of the operating system on which the executable runs, unless that component itself accompanies the executable.

If distribution of executable or object code is made by offering access to copy from a designated place, then offering equivalent access to copy the source code from the same place counts as distribution of the source code, even though third parties are not compelled to copy the source along with the object code.

4. You may not copy, modify, sublicense, or distribute the Program except as expressly provided under this License. Any attempt otherwise to copy, modify, sublicense or distribute the Program is void, and will automatically terminate your rights under this License. However, parties who have received copies, or rights, from you under this License will not have their licenses terminated so long as such parties remain in full compliance.

5. You are not required to accept this License, since you have not signed it. However, nothing else grants you permission to modify or distribute the Program or its derivative works. These actions are prohibited by law if you do not accept this License.

Therefore, by modifying or distributing the Program (or any work based on the Program), you indicate your acceptance of this License to do so, and all its terms and conditions for copying, distributing or modifying the Program or works based on it.

6. Each time you redistribute the Program (or any work based on the Program), the recipient automatically receives a license from the original licensor to copy, distribute or modify the Program subject to these terms and conditions. You may not impose any further restrictions on the recipients' exercise of the rights granted herein. You are not responsible for enforcing compliance by third parties to this License.

7. If, as a consequence of a court judgment or allegation of patent infringement or for any other reason (not limited to patent issues), conditions are imposed on you (whether by court order, agreement or otherwise) that contradict the conditions of this License, they do not excuse you from the conditions of this License. If you cannot distribute so as to satisfy simultaneously your obligations under this License and any other pertinent obligations, then as a consequence you may not distribute the Program at all. For example, if a patent license would not permit royalty-free redistribution of the Program by all those who receive copies directly or indirectly through you, then the only way you could satisfy both it and this License would be to refrain entirely from distribution of the Program.

If any portion of this section is held invalid or unenforceable under any particular circumstance, the balance of the section is intended to apply and the section as a whole is intended to apply in other circumstances.

It is not the purpose of this section to induce you to infringe any patents or other property right claims or to contest validity of any such claims; this section has the sole purpose of protecting the integrity of the free software distribution system, which is implemented by public license practices. Many people have made generous contributions to the wide range of software distributed through that system in reliance on consistent application of that system; it is up to the author/donor to decide if he or she is willing to distribute software through any other system and a licensee cannot impose that choice.

This section is intended to make thoroughly clear what is believed to be a consequence of the rest of this License.

8. If the distribution and/or use of the Program is restricted in certain countries either by patents or by copyrighted interfaces, the original copyright holder who places the Program under this License may add an explicit geographical distribution limitation excluding those countries, so that distribution is permitted only in or among countries not thus excluded. In such case, this License incorporates the limitation as if written in the body of this License.

9. The Free Software Foundation may publish revised and/or new versions of the General Public License from time to time. Such new versions will be similar in spirit to the present version, but may differ in detail to address new problems or concerns.

Each version is given a distinguishing version number. If the Program specifies a version number of this License which applies to it and "any later version", you have the option of following the terms and conditions either of that version or of any later version published by the Free Software Foundation. If the Program does not specify a version number of this License, you may choose any version ever published by the Free Software Foundation.

10. If you wish to incorporate parts of the Program into other free programs whose distribution conditions are different, write to the author to ask for permission. For software which is copyrighted by the Free Software Foundation, write to the Free Software Foundation; we sometimes make exceptions for this. Our decision will be guided by the two goals of preserving the free status of all derivatives of our free software and of promoting the sharing and reuse of software generally.

NO WARRANTY

11. BECAUSE THE PROGRAM IS LICENSED FREE OF CHARGE, THERE IS NO WARRANTY FOR THE PROGRAM, TO THE EXTENT PERMITTED BY APPLICABLE LAW. EXCEPT WHEN OTHERWISE STATED IN WRITING THE COPYRIGHT HOLDERS AND/OR OTHER PARTIES PROVIDE THE PROGRAM "AS IS" WITHOUT WARRANTY OF ANY KIND, EITHER EXPRESSED OR IMPLIED, INCLUDING, BUT NOT LIMITED TO, THE IMPLIED WARRANTIES OF MERCHANTABILITY AND FITNESS FOR A PARTICULAR PURPOSE. THE ENTIRE RISK AS TO THE QUALITY AND PERFORMANCE OF THE PROGRAM IS WITH YOU. SHOULD THE PROGRAM PROVE DEFECTIVE, YOU ASSUME THE COST OF ALL NECESSARY SERVICING, REPAIR OR CORRECTION.

12. IN NO EVENT UNLESS REQUIRED BY APPLICABLE LAW OR AGREED TO IN WRITING WILL ANY COPYRIGHT HOLDER, OR ANY OTHER PARTY WHO MAY MODIFY AND/OR REDISTRIBUTE THE PROGRAM AS PERMITTED ABOVE, BE LIABLE TO YOU FOR DAMAGES, INCLUDING ANY GENERAL, SPECIAL, INCIDENTAL OR CONSEQUENTIAL DAMAGES ARISING OUT OF THE USE OR INABILITY TO USE THE PROGRAM (INCLUDING BUT NOT LIMITED TO LOSS OF DATA OR DATA BEING RENDERED INACCURATE OR LOSSES SUSTAINED BY YOU OR THIRD PARTIES OR A FAILURE OF THE PROGRAM TO OPERATE WITH ANY OTHER PROGRAMS), EVEN IF SUCH HOLDER OR OTHER PARTY HAS BEEN ADVISED OF THE POSSIBILITY OF SUCH DAMAGES.



EDIMAX
NETWORKING PEOPLE TOGETHER

The logo features the word "EDIMAX" in a bold, white, sans-serif font. The letter "i" is lowercase and has a red dot above it. Below the brand name, the tagline "NETWORKING PEOPLE TOGETHER" is written in a smaller, white, all-caps sans-serif font. The background is a dark grey/black horizontal band filled with various white line-art icons, including a handshake, musical notes, a smiley face, a game controller, a computer monitor, and a network diagram. A thin, dark purple horizontal bar is located at the bottom of the image.