

Handle unit standard, without Fuse monitoring, for Size NH3, accessory for fuse switch disconnecter 3NP1



Wersja

Nazwa markowa produktu	SETRON
wykonanie produktu	Wyposażenie do bezpiecznikowego rozłącznika izolacyjnego 3NP1

Certyfikaty

General Product Approval

[Miscellaneous](#)

Declaration of Conformity



EG-Konf.

Więcej informacji

Information- and Downloadcenter (Catalogs, Brochures,...)

<http://www.siemens.com/lowvoltage/catalogs>

Industry Mall (Online ordering system)

<https://mall.industry.siemens.com/mall/en/en/Catalog/product?mlfb=3NP1963-1GA00>

Service&Support (Manuals, Certificates, Characteristics, FAQs,...)

<https://support.industry.siemens.com/cs/ww/pl/ps/3NP1963-1GA00>

Image database (product images, 2D dimension drawings, 3D models, device circuit diagrams, ...)

http://www.automation.siemens.com/bilddb/cax_en.aspx?mlfb=3NP1963-1GA00

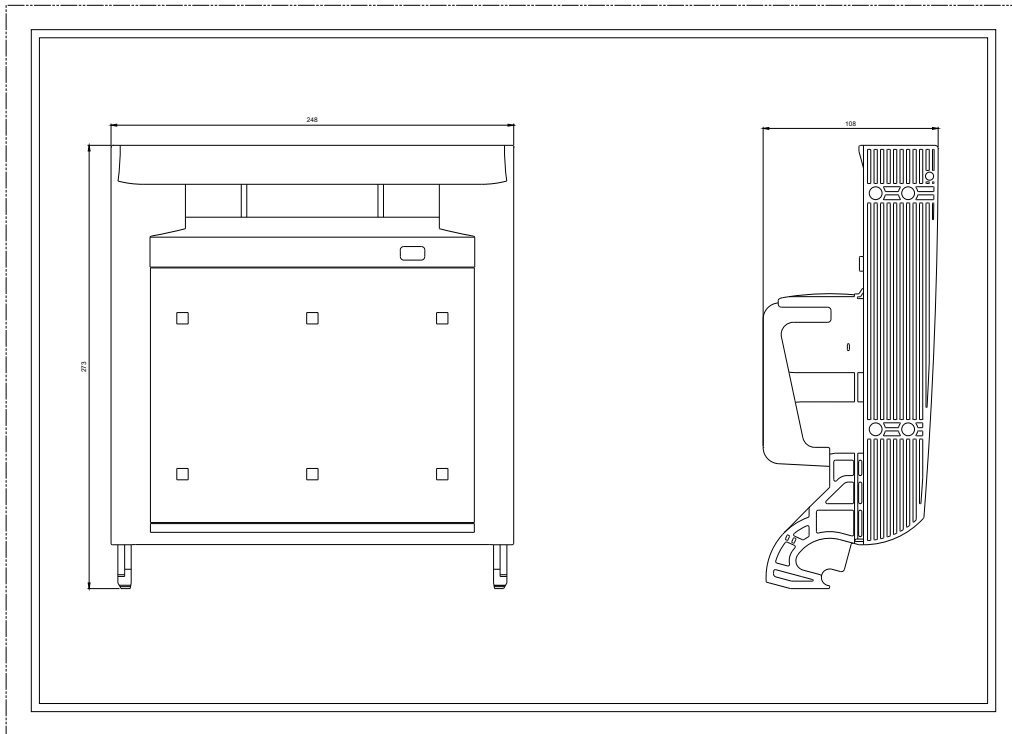

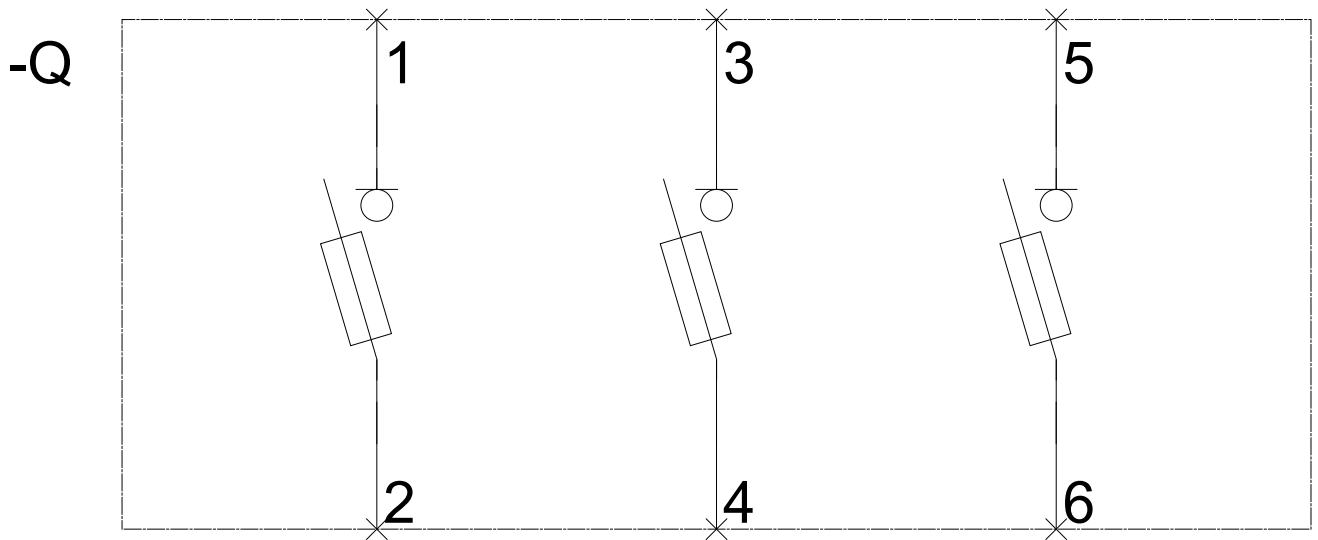

-CB

