

Handle unit with EFM25, for Size NH00, accessory for fuse switch disconnector 3NP1



Versão

Nome da marca do produto

SETRON

Certificados

General Product Approval	Declaration of Conformity	Test Certificates
--------------------------	---------------------------	-------------------

[Miscellaneous](#)

[Type Test Certificates/Test Report](#)



EG-Konf.

Outras informações

Information- and Downloadcenter (Catalogs, Brochures,...)

<http://www.siemens.com/lowvoltage/catalogs>

Industry Mall (Online ordering system)

<https://mall.industry.siemens.com/mall/pt/pt/Catalog/product?mlfb=3NP1933-1GB50>

Service&Support (Manuals, Certificates, Characteristics, FAQs,...)

<https://support.industry.siemens.com/cs/ww/pt/ps/3NP1933-1GB50>

Image database (product images, 2D dimension drawings, 3D models, device circuit diagrams, ...)

http://www.automation.siemens.com/bilddb/cax_en.aspx?mlfb=3NP1933-1GB50

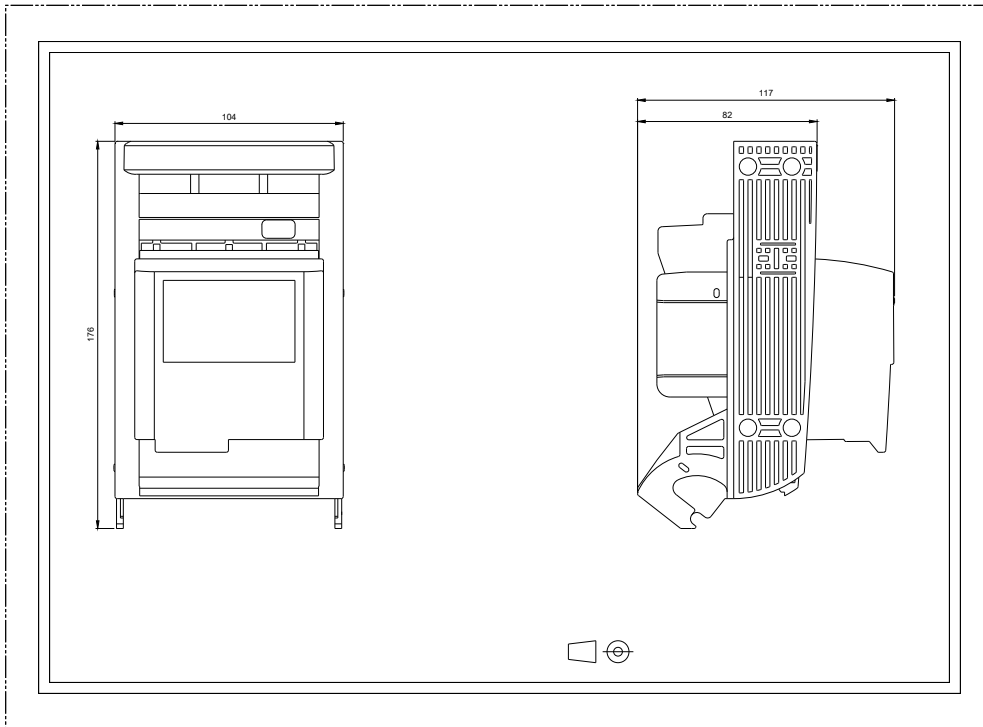

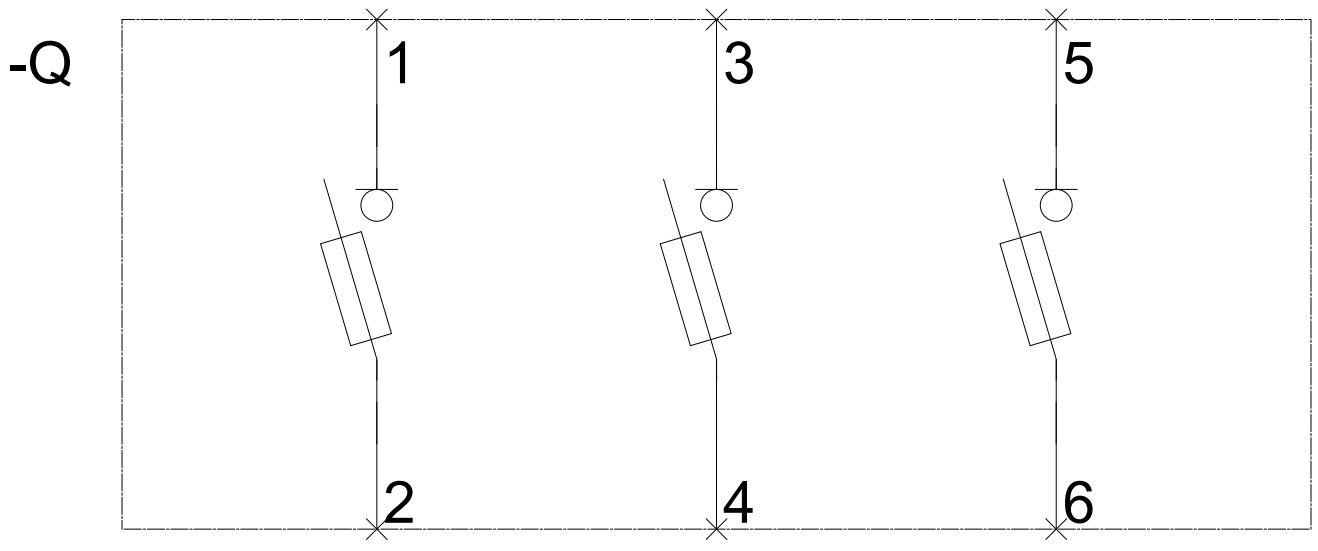

-CB

