

脚踏开关 2 个转换触点 2 个踏板，不带保护罩



产品名称	脚踏式按键
应用适宜性 安全	不

综合技术数据	
防护等级 IP	IP65
参考标示 符合 IEC 81346-2:2009	S
参考标示 符合 DIN EN 61346-2	S
转换等级的数量	1
操作踏板的数目	2
常闭触点数量 用于辅助触点	0
常开触点数量 用于辅助触点	0
转换器数量 用于辅助触点	2
工作电流	5 A
<ul style="list-style-type: none"> <li>AC-15 时 230 V 时 测定值</li> </ul>	

箱体	
材料 外壳的	带有绝缘保护的塑料
颜色	
<ul style="list-style-type: none"> <li>外壳的</li> </ul>	黑色
<ul style="list-style-type: none"> <li>外壳上部部件的</li> </ul>	黑色









## 操作装置

<b>产品装备</b>	
• 锁紧装置	不
• 锁定	不
<b>进线管的规格</b>	导线 , 3m

## 装入/固定/外廓尺寸

<b>紧固类型</b>	螺栓固定
<b>高度</b>	108 mm
<b>宽度</b>	212 mm
<b>深度</b>	34 mm

## 正树/批准：

General Product Approval		Declaration of Conformity			
 CCC	 CSA	 UL	 EAC	 EG-Konf.	<a href="#">Miscellaneous</a>
Test Certificates	Marine / Shipping			other	
<a href="#">Miscellaneous</a>	 ABS	 LRS	 PRS	 RINA	<a href="#">Confirmation</a>

## 更多信息

**Information- and Downloadcenter (产品目录, 产品介绍册, ...)**

[www.siemens.com/sirius/catalogs](http://www.siemens.com/sirius/catalogs)

**Industry Mall (网上订购系统)**

<https://mall.industry.siemens.com/mall/zh/zh/Catalog/product?mlfb=3SE3934-5CB20>

**Cax 在线发生器**

<http://support.automation.siemens.com/WW/CAXorder/default.aspx?lang=en&mlfb=3SE3934-5CB20>

**Service&Support (用户手册, 操作说明书, 认证证书, 特性曲线, 常见问题,...)**

<https://support.industry.siemens.com/cs/ww/zh/ps/3SE3934-5CB20>

**图片数据库 (产品照片, 2D比例图, 3D模型, 设备电路图, EPLAN Makros, ...)**

[http://www.automation.siemens.com/bilddb/cax\\_de.aspx?mlfb=3SE3934-5CB20&lang=en](http://www.automation.siemens.com/bilddb/cax_de.aspx?mlfb=3SE3934-5CB20&lang=en)

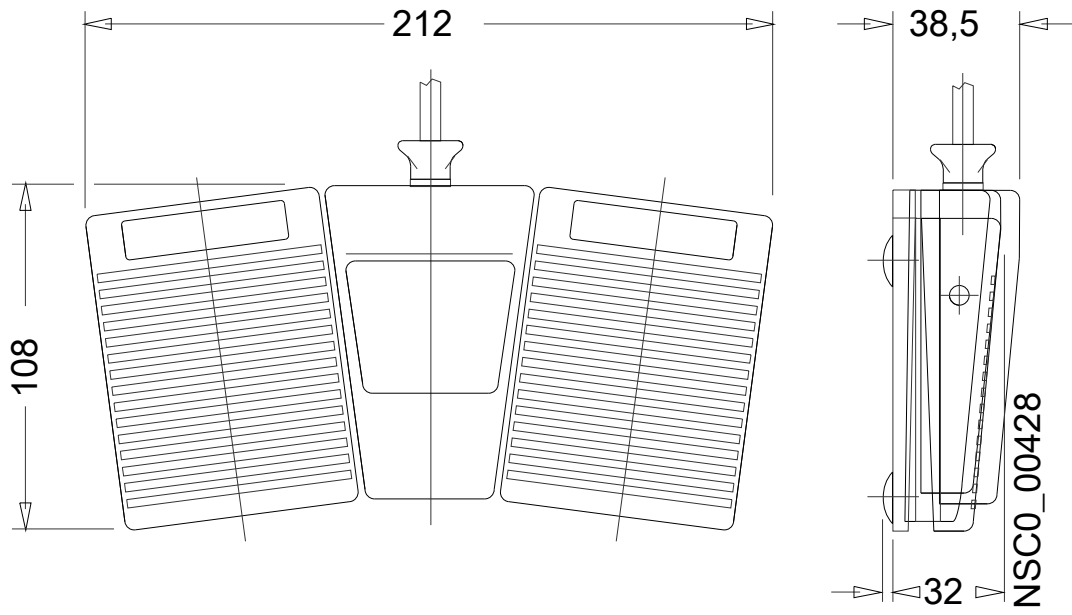

上一次修改：

2019/9/12